

Excéntrica Minifix Ø15 mm.

HÄFELE

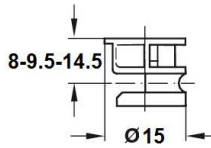

- 00402.0260.1 - Ø15x12,5 mm. centro 8 mm.
- 00402.0260.2 - Ø15x14 mm. centro 9,5 mm.
- 00402.0260.3 - Ø15x19,5 mm. centro 14,5 mm.

Embalaje: 1 / 200 uds.



- 00402.0260.TB - Blanco
- 00402.0260.TG - Gris
- 00402.0260.TN - Negro
- 00402.0260.TM - Marrón
- 00402.0260.TX - Beig

Tapa plástico Ø18 mm.
Embalaje: 1 / 500 uds.

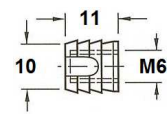

- 00405.0024 - M6
- Tuerca nylon
- Taladro: Ø10x11 mm.
- Embalaje: 1 / 1.000 uds.

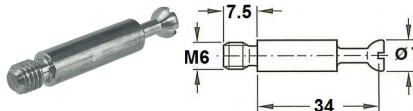

- 00402.0260.P1 - Perno M6x7,5 mm.

Embalaje: 1 / 200 uds.

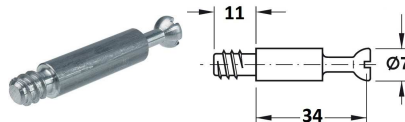

- 00402.0260.P2

Perno rosca madera Ø5x11 mm.
Embalaje: 1 / 200 uds.

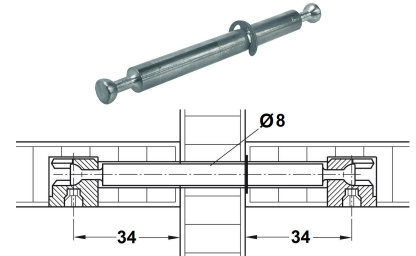

- 00402.0260.P3 - Perno doble con anillo

Distancia 34 mm. (lateral 19 mm.)
Embalaje: 1 / 100 uds.

Excéntrica Rondorfix Ø25 mm.

HÄFELE

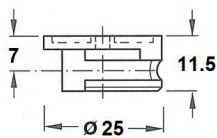

- 00402.0270 - Ø25x11,5 mm. centro 7 mm.

Embalaje: 1 / 100 uds.

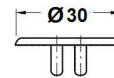

- 00402.0270.TB - Blanco
- 00402.0270.TM - Marrón

Tapa plástico Ø30 mm.
Embalaje: 1 / 100 uds.

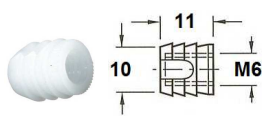

- 00405.0024 - M6
- Tuerca nylon
- Taladro: Ø10x11 mm.
- Embalaje: 1 / 1.000 uds.

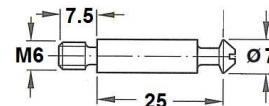

- 00402.0270.P - Perno M6x7,5 mm.

Embalaje: 1 / 100 uds.

Tuercas para embutir



- 00405.0020.6 - M6
- 00405.0020.8 - M8
- Tuerca hierro 4 púas
- Embalaje: 1 / 1.000 uds.



- 00405.0703.06 - M6
- 00405.0703.08 - M8
- 00405.0703.10 - M10
- Tuerca zamak
- M6 - taladro Ø8x13 mm.
- M8 - taladro Ø10x15 mm.
- M10 - taladro Ø12x18 mm.
- Embalaje: 1 / 5.000 uds.



- 00405.0023.08 - Ø8x19 mm.
- 00405.0023.10 - Ø10x14 mm.
- Tuerca hierro bicromatado
- Rosca 1/4
- Embalaje: 1 / 1.000 uds.



- 00405.0024 - M6
- Tuerca nylon
- Taladro: Ø10x11 mm.
- Embalaje: 1 / 1.000 uds.

Tuercas de latón para embutir

EFFEGIBREVETTI

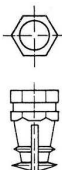
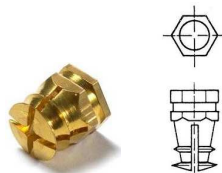

- 00405.0410.S - M4 taladro Ø5x10 mm.
- 00405.0612.S - M6 taladro Ø8x12 mm.
- 00405.0613.S - M6 taladro Ø10x13 mm.
- 00405.0813.S - M8 taladro Ø10x13 mm.
- Tuerca latón sin bola expansiva
- Embalaje: 1 / 1.000 uds.



- 00405.0410 - M4 taladro Ø5x10 mm.
- 00405.0609 - M6 taladro Ø8x9 mm.
- 00405.0612 - M6 taladro Ø8x12 mm.
- Tuerca latón con bola expansiva
- Embalaje: 1 / 1.000 uds.

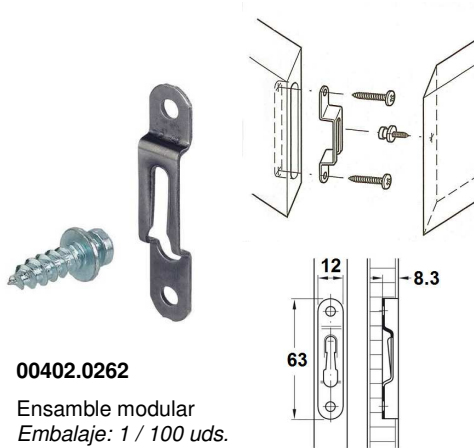

00402.0262
Ensamble modular
Embalaje: 1 / 100 uds.



00402.0038.35 - Tornillo 35 mm.
00402.0038.45 - Tornillo 45 mm.
00402.0039.B - Tapa blanco
00402.0039.M - Tapa marrón
Ensamble Ø35 mm. tuerca latón
Embalaje: 1 / 50 uds.

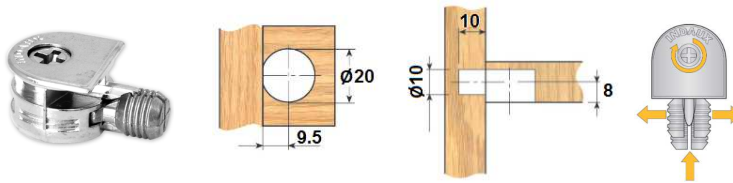

00402.0526 - Ensamble Clock-6 Ø20x13 mm. niquelado
Al girar el tornillo expande el tetón y atrae el tablero
Embalaje: 1 / 500 uds.

INDAUX



00407.0101_
Tornillo cabeza romana rosca 3/8
con tuerca latonada y arandela.
Medidas disponibles:
50-80-110 mm.
Embalaje: 1 / 100 uds.

Ensamblajes mesa

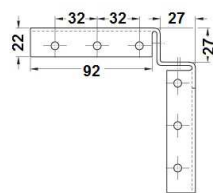

00408.0641 - Zincado
Ensamble mesa angular 125x125x54 mm.
Embalaje: 4 uds.

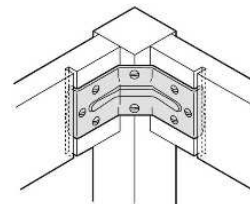
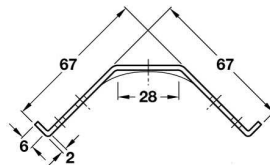

00408.0642 - Zincado
Ensamble mesa para marco 67x67x70 mm.
Embalaje: 4 uds.

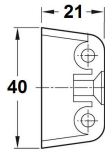
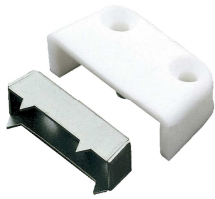

00401.0167.B

Ensamble blanco con tornillo 40x21 mm.
Embalaje: 1 / 100 uds.

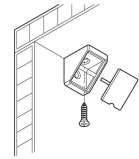
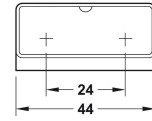
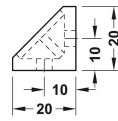

00401.0180.B - Blanco
00401.0180.BE - Beig

Ensamble plástico con tapa 44x20 mm.
Embalaje: 1 / 100 uds.



00401.0037

Ensamble hierro bicromatado 40x35 mm.
Embalaje: 1 / 50 uds.



00408.0030

Enganche cama
hierro zincado
Embalaje: 1 / 24 uds.



00403.0264.5 - Ø5x50 mm.
00403.0264.7 - Ø7x50 mm.
00403.0264_ - Tapa plástico
Tornillo ensamble allen zincado
Tapas: negro, marrón, beig.
Embalaje: 1 / 2.000 uds.



00403.0247.6 - M6x60 mm.
00403.0247.7 - M6x70 mm.
Tornillo doble rosca
Embalaje: 1 / 250 uds.



00403.1020.N1 - M6x13 mm.
00403.1020.N4 - M6x40 mm.
00403.1020.N5 - M6x50 mm.
00403.1020.N6 - M6x60 mm.
Tornillo hierro niquelado
Embalaje: 1 / 250 uds.



00404.0118.N - Tubo M4

Tubo unión niquelado Ø5x27mm.
con tornillo niquelado M-4x15 mm.
(para espesores de 28 a 39 mm.)
Embalaje: 1 / 4.000 uds.



00404.4004.30 - rosca 1/4 largo 30 mm.

00404.4004.35 - rosca 1/4 largo 35 mm.
Tubo unión zincado Ø8 mm.

00404.4004.L1 - Tornillo latonado 10 mm.
00404.4004.N1 - Tornillo niquelado 10 mm.
00404.4004.N4 - Tornillo niquelado 45 mm.
Tornillo rosca 1/4

Embalaje: 1 / 1.000 uds.



Tuerca hexagonal

00405.0004 - rosca M4 zinc
00404.0006 - rosca M6 zinc
00404.0008 - rosca M8 zinc

Tuerca ciega latón

00406.0006.LS - M6, latón brillo 10x10 mm.
00406.0006.NS - M6, níquel satinado 10x10 mm.
00406.0008.NS - M8, níquel satinado 14x14 mm.

Tuerca ciega Inox

00406.0008.I - M8, inox brillo 13x15 mm.
Embalaje: 1 / 100 uds.